

EYES FLAT RECESSED

E10R0015-

base number _____ Color _____
 _____ Temperature _____

- To build a product code in our configurator select the specify button on the base model # product page
- To build a manual product code on this datasheet choose from the options listed below in blue font and add the suffix to the base model #

GENERAL

Series: Eyes _____
 Subseries: Eyes Flat _____
 Brand: Side _____
 Division: Exterior _____
 Mounting Type: Recessed _____
 Mounting Location: Wall / Ceiling _____
 Subcategory: Downlight _____

PHYSICAL

Shape: Square _____
 Length (mm): 36 _____
 Length (in): 1 7/16 _____
 Width (mm): 36 _____
 Width (in): 1 7/16 _____
 Height (mm): 61 _____
 Height (in): 2 3/8 _____
 Min. Recessing Depth (mm): 66 _____
 Min. Recessing Depth (in): 2 5/8 _____
 Light Distribution: Direct _____
 Weight (kg): 0.08 _____
 Weight (lbs): 0.18 _____
 Diffuser: Transparent methacrylate _____
 Gasket: Silicon rubber _____
 Fixture Finish: Chrome _____
 Fixture Material: Aluminum Die Cast _____

ELECTRICAL

Lamp Type: LED (Zhaga Standard) _____
 Input Wattage (W): 4.5 _____
 Total Output Wattage (W): 3 _____
 Dimming: Non-Dimming / Phase Dimming (120Vac only) / 0-10V Dimming _____
 Driver Included: No _____
 Driver Location: Remote _____
 Driver Type: Constant Current - 120 / 277Vac _____
 Driver Class: Class 2 _____
 Input Voltage (V): 120 - 277 _____
 Constant Current (mA): 350 _____
 Constant Voltage (V): 8.75 _____
 Upon Request: Requires a minimum of 2 fixtures for 0-10V dimming options _____

LED

Color Temperature (°K): 3000 / 4000 _____
 Max. Delivered Lumen (lm): 285 / 300 _____
 Nominal Lumen (lm): 350 / 380 _____
 CRI: >80 CRI _____
 Lamp Life (hrs): 50000 _____

OPTICAL

Optic°: 45 _____

RATINGS AND CERTIFICATIONS

Certified By: Certified for North American Standards _____
 IP rating: IP68 _____

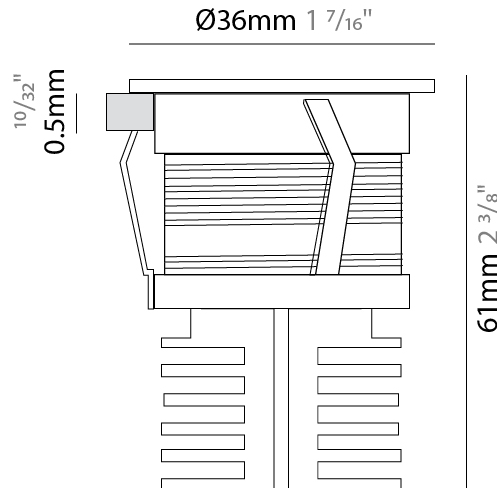
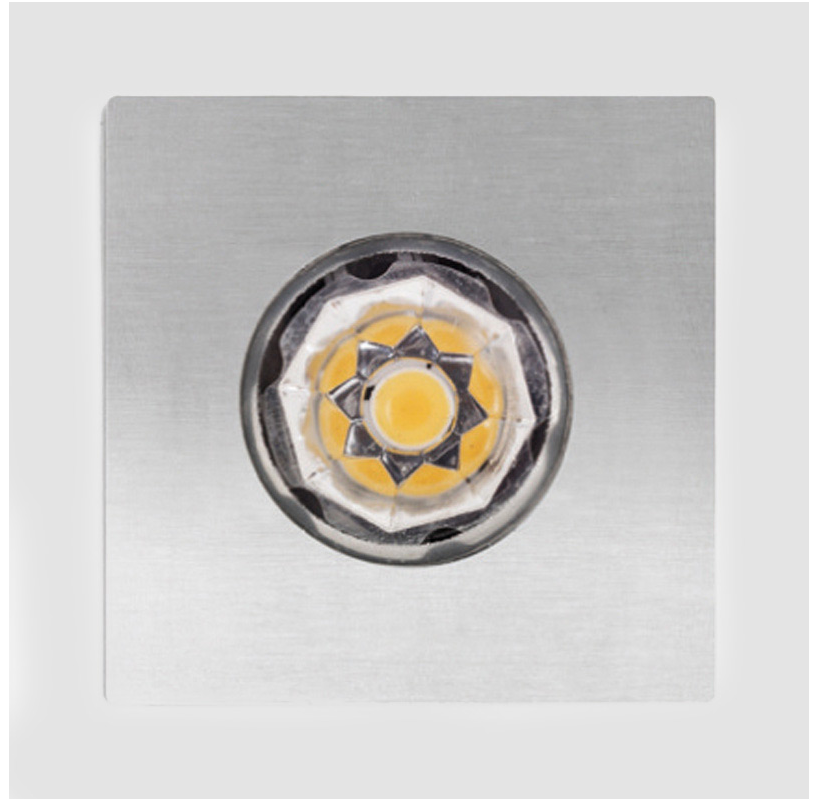

0.08kg / 0.18 lbs

28mm 1 1/8"



PROJECT	_____
TYPE	_____
SPECIFIER	_____
QUANTITY	_____
DATE	_____

EYES ROUND RECESSED

E10R0107-

base number _____ Color _____
 _____ Temperature _____

- To build a product code in our configurator select the specify button on the base model # product page
- To build a manual product code on this datasheet choose from the options listed below in blue font and add the suffix to the base model #

GENERAL

Series: Eyes _____
 Subseries: Eyes Round _____
 Brand: Side _____
 Division: Exterior _____
 Mounting Type: Recessed _____
 Mounting Location: Ceiling _____
 Subcategory: Downlight _____

PHYSICAL

Shape: Round _____
 Diameter (mm): 20 _____
 Diameter (in): 13/16 _____
 Depth (mm): 28 _____
 Depth (in): 1 1/8 _____
 Min. Recessing Depth (mm): 33 _____
 Min. Recessing Depth (in): 1 5/16 _____
 Light Distribution: Direct _____
 Weight (kg): 0.02 _____
 Weight (lbs): 0.044 _____
 Gasket: Silicon rubber _____
 Fixture Finish: Chrome _____
 Fixture Material: Aluminum Die Cast _____

ELECTRICAL

Lamp Type: LED (Zhaga Standard) _____
 Input Wattage (W): 1.2 _____
 Total Output Wattage (W): 1 _____
 Dimming: Non-Dimming / Phase Dimming (120Vac only) / 0-10V Dimming _____
 Driver Included: No _____
 Driver Location: Remote _____
 Driver Type: Constant Current - 120 / 277Vac _____
 Driver Class: Class 2 _____
 Input Voltage (V): 120 - 277 _____
 Constant Current (MA): 350 _____

LED

Number of LEDs: 1 _____
 Color Temperature (°K): 3000 / 4000 _____
 Max. Delivered Lumen (lm): 58.4 / 64.9 _____
 Nominal Lumen (lm): 120 / 125 _____
 CRI: >80 CRI _____
 Lamp Life (hrs): 50000 _____

OPTICAL

Optic°: 100° _____

RATINGS AND CERTIFICATIONS

Certified By: Certified for North American Standards _____
 IP rating: IP68 _____

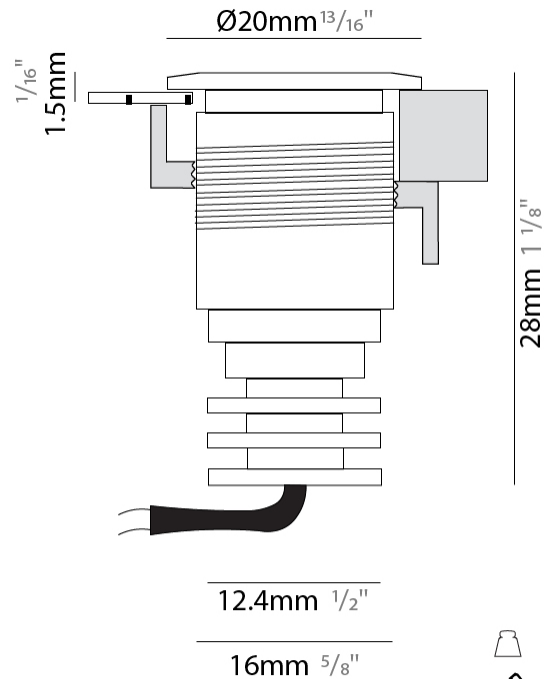
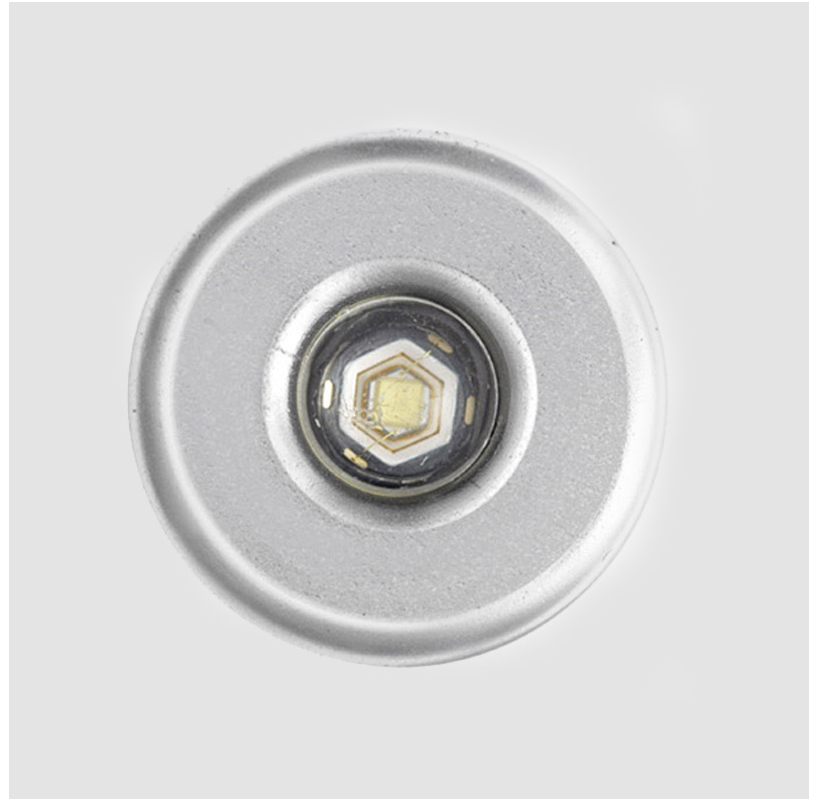

	0.08kg / 0.18 lbs
	28mm 1 1/8"
	10 / 12.5 / 15 mm 3/8" / 1/2" / 9/16"



EYES SQUARE RECESSED

E10R0113-

base number _____ Color _____
 Temperature _____

- To build a product code in our configurator select the specify button on the base model # product page
- To build a manual product code on this datasheet choose from the options listed below in blue font and add the suffix to the base model #

GENERAL

Series: Eyes _____
 Subseries: Eyes Square _____
 Brand: Side _____
 Division: Exterior _____
 Mounting Type: Recessed _____
 Mounting Location: Ceiling _____
 Subcategory: Downlight _____

PHYSICAL

Shape: Square _____
 Length (mm): 20 _____
 Length (in): 13/16 _____
 Width (mm): 20 _____
 Width (in): 13/16 _____
 Depth (mm): 28 _____
 Depth (in): 1 1/8 _____
 Min. Recessing Depth (mm): 33 _____
 Min. Recessing Depth (in): 1 5/16 _____
 Light Distribution: Direct _____
 Weight (kg): 0.02 _____
 Weight (lbs): 0.044 _____
 Gasket: Silicon rubber _____
 Fixture Finish: Chrome _____
 Fixture Material: Aluminum Die Cast _____

ELECTRICAL

Lamp Type: LED (Zhaga Standard) _____
 Total Output Wattage (W): 1.2 _____
 Dimming: Non-Dimming / Phase Dimming (120Vac only) / 0-10V Dimming _____
 Driver Included: No _____
 Driver Location: Remote _____
 Driver Type: Constant Current - 120 / 277Vac _____
 Driver Class: Class 2 _____
 Input Voltage (V): 120 - 277 _____
 Constant Current (MA): 350 _____

LED

Number of LEDs: 1 _____
 Color Temperature (°K): 3000 / 4000 _____
 Max. Delivered Lumen (lm): 58.4 / 64.9 _____
 Nominal Lumen (lm): 120 / 125 _____
 CRI: >80 CRI _____
 Lamp Life (hrs): 50000 _____

OPTICAL

Optic°: 100° _____

RATINGS AND CERTIFICATIONS

Certified By: Certified for North American Standards _____
 IP rating: IP68 _____

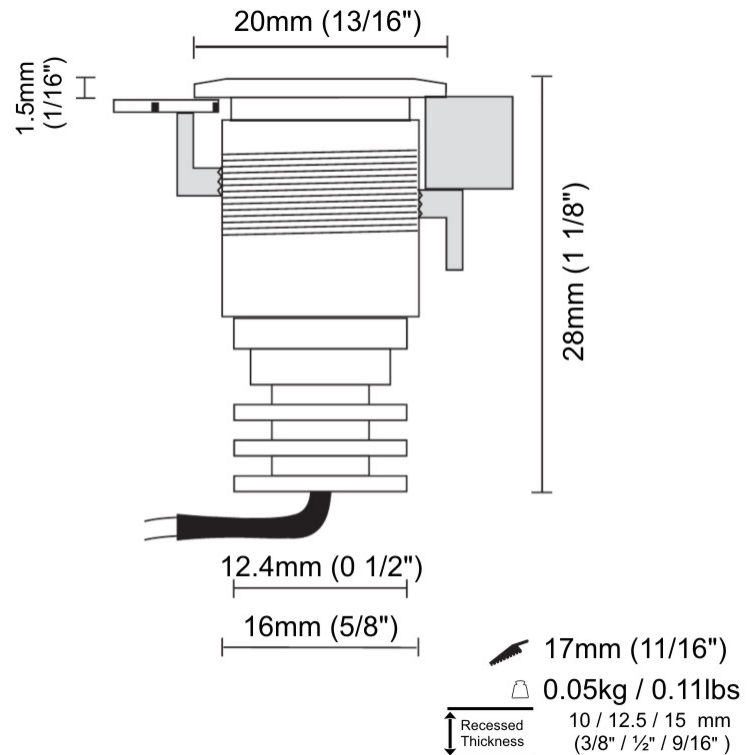

PROJECT	_____
TYPE	_____
SPECIFIER	_____
QUANTITY	_____
DATE	_____

EYES ROUND RECESSED

E10R0120-

base number _____ Color _____
 _____ Temperature _____

- To build a product code in our configurator select the specify button on the base model # product page
- To build a manual product code on this datasheet choose from the options listed below in blue font and add the suffix to the base model #

GENERAL

Series: Eyes _____
 Subseries: Eyes Round _____
 Brand: Side _____
 Division: Exterior _____
 Mounting Type: Recessed _____
 Mounting Location: Ceiling _____
 Subcategory: Downlight _____

PHYSICAL

Shape: Round _____
 Diameter (mm): 20 _____
 Diameter (in): 13/16 _____
 Height (mm): 28 _____
 Height (in): 1 1/8 _____
 Min. Recessing Depth (mm): 33 _____
 Min. Recessing Depth (in): 1 5/16 _____
 Light Distribution: Direct _____
 Weight (kg): 0.02 _____
 Weight (lbs): 0.044 _____
 Gasket: Silicon rubber _____
 Fixture Finish: Chrome _____
 Fixture Material: Aluminum Die Cast _____

ELECTRICAL

Lamp Type: LED (Zhaga Standard) _____
 Total Output Wattage (W): 1.2 _____
 Dimming: 0-10V Dimming / Phase Dimming (120Vac Only) _____
 Driver Included: No _____
 Driver Location: Remote _____
 Driver Type: Constant Current - 120 / 277Vac _____
 Input Voltage (V): 120 - 277 _____
 Constant Current (MA): 350 _____
 Upon Request: (Not included - see components [IP65 or higher enclosure to be supplied by others]) Remote: 0-10Vdc dimming / Phase dimming @120Vac only / 277Vac _____

LED

Number of LEDs: 1 _____
 Color Temperature (°K): 3000 / 4000 _____
 Max. Delivered Lumen (lm): 58.4 / 64.9 _____
 Nominal Lumen (lm): 120 / 125 _____
 CRI: >80 CRI _____
 Lamp Life (hrs): 50000 _____

OPTICAL

Optic°: 100° _____

RATINGS AND CERTIFICATIONS

Certified By: Certified for North American Standards _____
 IP rating: IP68 _____

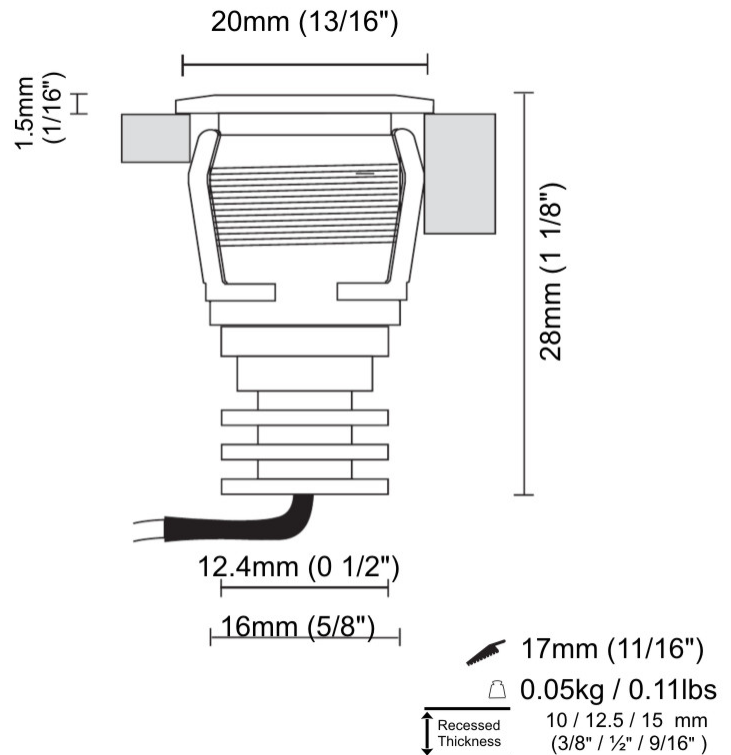
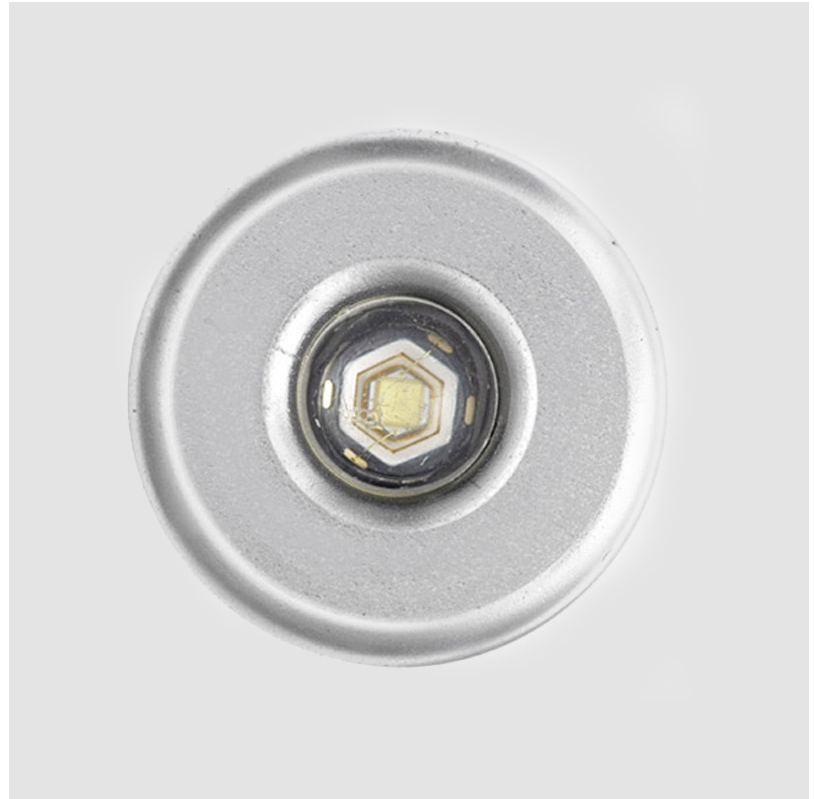

EYES SQUARE RECESSED

E10R0126-

base number _____
 Color _____
 Temperature _____

- To build a product code in our configurator select the specify button on the base model # product page
- To build a manual product code on this datasheet choose from the options listed below in blue font and add the suffix to the base model #

GENERAL

Series: Eyes _____
 Subseries: Eyes Square _____
 Brand: Side _____
 Division: Exterior _____
 Mounting Type: Recessed _____
 Mounting Location: Ceiling _____
 Subcategory: Downlight _____

PHYSICAL

Shape: Square _____
 Length (mm): 20 _____
 Length (in): 13/16 _____
 Width (mm): 20 _____
 Width (in): 13/16 _____
 Depth (mm): 28 _____
 Depth (in): 1 1/8 _____
 Min. Recessing Depth (mm): 33 _____
 Min. Recessing Depth (in): 1 5/16 _____
 Light Distribution: Direct _____
 Weight (kg): 0.05 _____
 Weight (lbs): 0.11 _____
 Gasket: Silicon rubber _____
 Fixture Finish: Chrome _____
 Fixture Material: Aluminum Die Cast _____

ELECTRICAL

Lamp Type: LED (Zhaga Standard) _____
 Total Output Wattage (W): 1.2 _____
 Dimming: 0-10V Dimming / Phase Dimming (120Vac Only) _____
 Driver Included: No _____
 Driver Location: Remote _____
 Driver Type: Constant Current - 120 / 277Vac _____
 Input Voltage (V): 120 - 277 _____
 Constant Current (mA): 350 _____
 Upon Request: (Not included - see components [IP65 or higher enclosure to be supplied by others]) Remote: 0-10Vdc dimming / Phase dimming @120Vac only / 277Vac _____

LED

Number of LEDs: 1 _____
 Color Temperature (°K): 3000 / 4000 _____
 Max. Delivered Lumen (lm): 58.4 / 64.9 _____
 Nominal Lumen (lm): 120 / 125 _____
 CRI: >80 CRI _____
 Lamp Life (hrs): 50000 _____

OPTICAL

Optic°: 100° _____

RATINGS AND CERTIFICATIONS

Certified By: Certified for North American Standards _____
 IP rating: IP68 _____

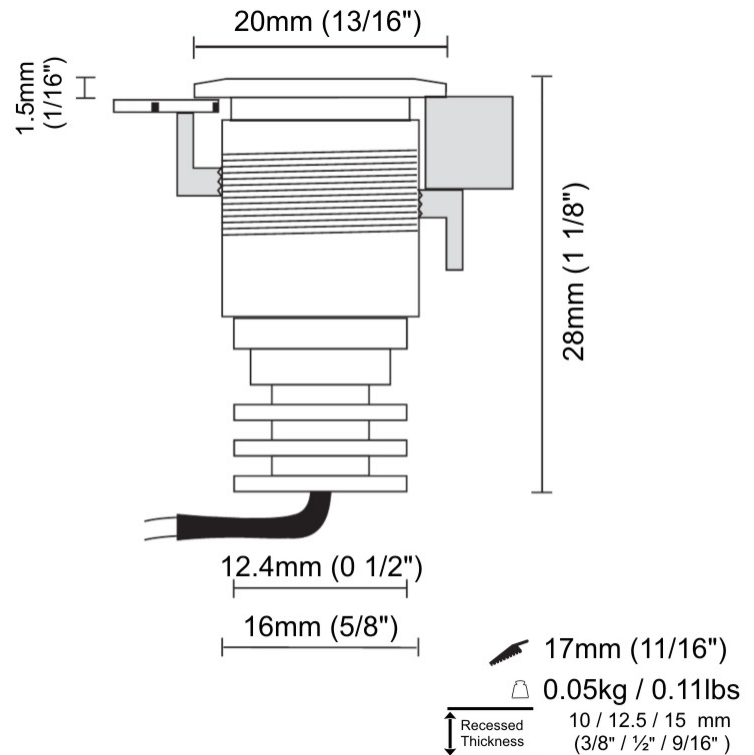

PROJECT

TYPE

SPECIFIER

QUANTITY

DATE





































































Fixture Finish

Digital: Not all screens are calibrated the same, and therefore, colors will appear differently between screens.











Physical: When texture is involved, there will be variations in color, character and tone within a product series and between product families.













LEGEND

	floor-mounted		pivotal		special LED (upon request) RGB, RGBW, tunable, gold+, meat+, art+, fashion+
	wall and ceiling: recessed and surface mounted		rotating		warm dim / natural dimming LED
	ceiling-mounted and wall-mounted		illuminate tilted		rechargeable battery powered
	wall-mounted		color of suspension cable		fixture with natural vivid LED (upon request)
	omni-directional light distribution		length of suspension cable		color rendering index
	direct light distribution		reflector degree selection		color temperature
	direct/indirect light distribution		super spot		lumen (luminous flux)
	indirect light distribution		lens		efficacy (lumens per watt)
	asymmetric light distribution		lens pack		Unified Glare Rating (UGR) range from 5-40
	aura light distribution		shine ring		marine grade (AISI 316 stainless steel)
	round wall or ceiling cut-out		integrated shine ring with diffuser		walk on
	square wall or ceiling cut-out		free individual colors 01-29		drive on
	the supplied jig specifies the cutout dimensions		individual colors: 00 (free of charge), 01-25 (extra charge)		Dark Sky Compliance
	minimum distance (meters) lamp - object		luminaire part to be colored (F1)		Americans with Disabilities Act (less than 4" off the wall located between 27"-84" from floor)
	recessed depth		luminaire part to be colored (F2)		lamp protected against explosion
	ceiling thickness in mm		luminaire part to be colored (F3)		blown glass using traditional methods by master glass blower
	ceiling thickness selection		luminaire part to be colored (F4)		acoustic material
	dimnable DP (phase), DV (0-10V), DD (dali), DS (step-dim)		luminaire part to be colored (F5)		protection class I, protection insulation
	included or excluded LED driver/transformer/control gear		color of 3-circuit adaptor		protection class II, protection insulation
	separately switchable		indirect diffuser		ETL Certified to UL and CSA Standards
	sensor		direct diffuser		UL Certified to UL and CSA Standards
	remote control		ball-proof (upon request)		CSA Certified to UL and CSA Standards
	available upon request		accessory		Certified for North American Standards

IP RATING

	protected against ingress of solid bodies greater than 12.5mm (finger)
	protected against ingress of solid bodies greater than 2.5mm protected against sprays of water up to 60 degrees from the vertical (rain)
	protected against ingress of solid bodies greater than 1mm (wire) no protection against the ingress of moisture
	protected against ingress of solid bodies greater than 1mm (wire) protected against sprays of water up to 60 degrees from the vertical (rain)
	protected against ingress of solid bodies greater than 1mm (wire) protected against water splashed from all directions
	protected against limited ingress of dust (wet rooms/covered outdoor areas) protected against water splashed from all directions
	protected against ingress of dust protected against jets of water
	protected against ingress of dust protected against powerful jets of water or heavy seas
	protected against ingress of dust protected against immersion of water between 15cm - 1m for 30 minutes
	protected against ingress of dust protected against immersion of water under pressure for long periods

IK RATING

	protected against 0.14 joules impact (equivalent to 0.25kg mass dropped from 56mm above the surface)
	protected against 0.2 joules impact (equivalent to 0.25kg mass dropped from 80mm above the surface)
	protected against 0.35 joules impact (equivalent to 0.25kg mass dropped from 140mm above the surface)
	protected against 0.5 joules impact (equivalent to 0.25kg mass dropped from 200mm above the surface)
	protected against 0.7 joules impact (equivalent to 0.25kg mass dropped from 280mm above the surface)
	protected against 1 joules impact (equivalent to 0.25kg mass dropped from 400mm above the surface)
	protected against 2 joules impact (equivalent to 0.5kg mass dropped from 400mm above the surface)
	protected against 5 joules impact (equivalent to 1.7kg mass dropped from 300mm above the surface)
	protected against 10 joules impact (equivalent to 5.0kg mass dropped from 200mm above the surface)
	protected against 20 joules impact (equivalent to 5.0kg mass dropped from 400mm above the surface)